

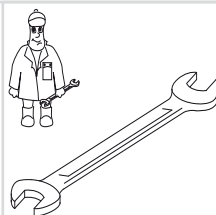

Gebr. Becker GmbH
Hölker Feld 29-31
D-42279 Wuppertal

Wartung
Maintenance
Entretien
Manutenzione
Mantenimiento



	Pos.	Menge ²⁾ Quantity Quantité Quantità Cantidad	Bestell-Nr. Ident No. No. Identification No. Identificazione No. de pedido	Bezeichnung Description Designation Designazione Descripción
KDT 3.100	...	1	549000 21300	Dichtungssatz, Complete set of seals, Jeu de joints, Kit di guarnizioni, Junta Completa
	11	SATZ (KIT)	901333 00004	Schieber, Rotor Vane, Palette, Empujador
	11	SATZ (KIT)	901380 00004	" (KDT 3.100/0-52 + KDT 3.100/6)
	11	SATZ (KIT)	901380 00007	" (KDT 3.100/6-29 + KDT 3.100/6-71)
	68	2	909507 00000	Filterpatrone, Filter cartridge, Cartouche Filtrante, Cartuccia filtro, Cartucho de filtro
	68	1	"	" (KDT 3.100/6)
	69	1	909587 00000	" (KDT 3.100/6) - Polyester
	91	1	909514 00000	Filterpatrone, Filter cartridge, Cartouche Filtrante, Cartuccia filtro, Cartucho de filtro

²⁾ erforderliche Bestellmenge / necessary order quantity / quantité nécessaire / quantità di ordinazione necessari / cantidad necesario



Ersatzteilliste
Spare parts list
Liste de pièces de rechange
Listino pezzi di ricambio
Lista de piezas de recambio
Lista de peças sobresselentes
Reserveonderdelenlijst
Reservedeliste
Reservdelista

Reservedelsliste
Varaosaluettelo
Wykaz części zamiennych
Seznam náhradních dílů
Tartalékalkatrész lista
Κατάλογος ανταλλακτικών
Перечень запасных частей
备用零件目录
スペアパーツリスト

KDT 3.100



28000021201_04/2010

Index-D

SERVICE

Qingpu - PR CHINA
www.becker-international.com

No. **D** year XXXX

type **KDT 3.100-XX** Index Option

frequency XXXX Hz

speed XXXX min⁻¹

power required XXXX kW

inlet capacity XXXX m³/h

pressure + XXXX mbar

vacuum - XXXX mbar

Made in China

D Service:

Tel: +49 (0)202 697-171

Fax: +49 (0)202 64 44 74

E-Mail: info@becker-international.com

www.becker-international.com



KDT 3.100

Pos.	Bestell Nr.	Beschreibung	
...	549000 21300	DICHTUNGSSATZ ¹⁾	
6	000101 21200	GEHÄUSE	
9	020005 21200	KOLBEN	
11	901333 00004	SCHIEBER (SATZ) ²⁾	
15	000803 21200	SEITENDECKEL, LINKS	
16	000701 21200	SEITENDECKEL, RECHTS	
17	025512 21200	DICHTUNG	
18	001100 21200	LAGERDECKEL	
19	001000 21200	LAGERDECKEL	
20	025513 21200	DICHTUNG	
24	911312 00000	DICHTUNGSSCHLAUCH	
25	917152 00000	AUSGLEICHSCHEIBE	
26	906540 00000	WELLENDICHRING	
27	906620 00000	WÄLZLAGER, 3205 C3 GBB20	
28	906657 00000	WÄLZLAGER, NU 205 E GBB30	
31	511400 10100	SATZ DISTANZSCHEIBEN	
38	016801 21100	SPANNSCHEIBE	
39	949807 00000	SENKSCRAUBE	
41	945224 00000	SECHSKANTSCHRAUBE	
42	945222 00000	SECHSKANTSCHRAUBE	
45	948742 00000	PASSKERBSTIFT	
47	947736 00000	PASSFEDER	
50	053201 21300	LATERNE	
52	950308 00000	UNTERLEGSCHNEIBE	
53	945331 00000	INNENSECHSKANTSCHRAUBE	
55	011400 21200	DISTANZSCHEIBE	
56	544500 21200	KUPPLUNGSHÄLFTE MIT VENTILATOR	
57	949409 00000	UNTERLEGSCHNEIBE	
58	945270 00000	WELLENENDSCHRAUBE	
61	040102 21300	FILTERGEHÄUSE	
62	025501 21300	DICHTUNG	
64	951009 00000	STIFTSCHRAUBE	
65	951003 00000	STIFTSCHRAUBE	
67	964407 00000	SCHALLDÄMPFERROHR	
68	909507 00000	FILTERPATRONE C 1112/2 (2x) ²⁾	
71	009000 27000	ANPRESSFEDER	
72	948750 00000	BLINDNIET	
73	040204 21300	FILTERDECKEL	
75	025518 21300	DICHTUNG	
76	025516 21100	DICHTUNG	
77	022802 21100	FILTERTRÄGER	
79	945321 00000	INNENSECHSKANTSCHRAUBE	
80	946971 00000	STIFTSCHRAUBE	
81	947504 00000	UNTERLEGSCHNEIBE	
82	947104 00000	SECHSKANTMUTTER	
83	952019 00000	SPANNHÜLSE	
85	025514 21100	DICHTUNG	
86	025515 21100	DICHTUNG	
88	560203 21300	KUEHLER	
91	909514 00000	FILTERPATRONE C 718 (1x) ²⁾	
93	903800 70000	STIFTSCHRAUBE	
94	947105 00000	SECHSKANTMUTTER	
95	949450 00000	U-SCHNEIBE	
97	950304 00000	U-SCHNEIBE	
98	945321 00000	INNENSECHSKANTSCHRAUBE	
103	068801 21300	STAUBABSCHNEIDERDECKEL	
104	025515 21300	DICHTUNG	
110	921500 50000	HANDGRIFF	
121	560204 21300	KÜHLER	
122	025506 21300	DICHTUNG	



KDT 3.100

Pos.	Bestell Nr.	Beschreibung	
123	066802 21300	DRUCKANSCHLUSSKASTEN	
125	025504 21300	DICHTUNG	
126	025514 21300	DICHTUNG	
131	948021 00000	DICHRING	
132	945374 00000	INNENSECHSKANTSCHRAUBE	
137	945322 00000	INNENSECHSKANTSCHRAUBE	
141	016604 21300	ANSCHLUSSLEISTE	
146	025507 21300	DICHTUNG	
148	945364 00000	INNENSECHSKANTSCHRAUBE	
149	741310 30000	GUMMIPUFFER	
161	918300 21300	ABDECKHAUBE	
163	920800 21300	LUFTLEITRING	
165	960700 21300	LÜFTERHAUBE	
166	960701 21300	LÜFTERHAUBE	
171	945371 00000	INNENSECHSKANTSCHRAUBE	
172	945372 00000	INNENSECHSKANTSCHRAUBE	
173	949806 00000	SENKSCRAUBE	
174	951703 00000	FEDERSCHNEIBE	
176	741302 00000	GUMMIPUFFER	
177	945634 00000	GEWINDESTIFT	
178	948802 00000	RINGSCHRAUBE	
182	014902 21300	ZWISCHENFLANSCH	
184	951916 00000	KABELTÜLLE	
185	948772 00000	ROHRNIETE	
186	947508 00000	UNTERLEGSCHNEIBE	
188	945335 00000	INNENSECHSKANTSCHRAUBE	
190	951018 00000	STIFTSCHRAUBE	
192	947506 00000	UNTERLEGSCHNEIBE	
193	947106 00000	SECHSKANTMUTTER	
197	902108 00000	KUPPLUNGSHÄLFTE (MOT)	
199	902210 00000	KUPPLUNGSSCHNEIBE	
241	012200 21200	LEITUNG	
244	912300 00000	ANSCHLUSSSCHRAUBE	
245	009400 19000	KUGELSTÜCKSCHRAUBE	
247	948074 00000	DICHRING	
248	948021 00000	DICHRING	
250	949002 00000	SCHMIERNIPPEL	
345	728000 99622	DRUCKREGULIERVENTIL / 0,6 BAR	
345	728001 99622	DRUCKREGULIERVENTIL / 1,0 BAR	
345	728002 99622	DRUCKREGULIERVENTIL / 2,0 BAR	
345	728003 99622	DRUCKREGULIERVENTIL / 0,3 BAR	
353	953111 00000	SCHALLDÄMPFERDÜSE	
354	912805 00000	VERSCHLUSSSTOPFEN	
	LAGERFETT 743303 00000	AMBLYGON TA15/2 (FETTPRESSE, 50g)	



¹⁾ Dichtungssatz - 54900021300 - Pos.: 17, 20, 24, 62, 75, 76, 85, 86, 104, 122, 125, 126, 146
²⁾ erforderliche Bestellmenge / Wartung

OPTIONAL

KDT 3.100	USA	alle Ausführungen
	B5-300	Sonderausführung - Motoranschluß
	/0-05	Sonderausführung - Korrosionsschutz
	/0-52	Sonderausführung - Korrosionsschutz und Spezialschieber
	/0-54	Sonderausführung - Kühlung
	/6-29	Sonderausführung - Korrosionsschutz und erhöhter Druck
	/6-54	Sonderausführung - Korrosionsschutz / Kühlung
	/6-71	Sonderausführung - Korrosionsschutz und erhöhter Druck

Abweichende Positionen zum Standardgerät - siehe Anhang (Zeichnungsrückseite)

D
Index**KDT 3.100**

Pos.	Ident No.	Description
...	549000 21300	COMPLETE SET OF SEALS ¹⁾
6	000101 21200	PUMP BODY
9	020005 21200	ROTOR
11	901333 00004	CARBON VANES (KIT) ²⁾
15	000803 21200	LID, LEFT
16	000701 21200	LID, RIGHT
17	025512 21200	GASKET
18	001100 21200	BEARING COVER, 3205 C3 GBB20
19	001000 21200	BEARING COVER, NU 205 E GBB30
20	025513 21200	GASKET
24	911312 00000	SEAL
25	917152 00000	COMPENSATING DISC
26	906540 00000	SHAFT-SEALING RING
27	906620 00000	BALL BEARING
28	906657 00000	BALL BEARING
31	511400 10100	SET DISTANCE DISC
38	016801 21100	CLAMPING DISC
39	949807 00000	SCREW
41	945224 00000	HEX-HEAD SCREW
42	945222 00000	HEX-HEAD SCREW
45	948742 00000	STRAIGHT PIN
47	947736 00000	KEY
50	053201 21300	CONNECTION FLANGE
52	950308 00000	WASHER
53	945331 00000	SOCKET HEAD SCREW
55	011400 21200	DISTANCE DISC
56	544500 21200	COUPLING WITH FAN
57	949409 00000	WASHER
58	945270 00000	SHAFT END BOLD
61	040102 21300	FILTER HOUSING
62	025501 21300	GASKET
64	951009 00000	STUD
65	951003 00000	STUD
67	964407 00000	SILENCER TUBE
68	909507 00000	FILTER CARTRIDGE C 1112/2 (2x) ²⁾
71	009000 27000	LEAF SPRING
72	948750 00000	BLIND RIVET
73	040204 21300	FILTER COVER
75	025518 21300	GASKET
76	025516 21100	GASKET
77	022802 21100	FILTER HOLDER
79	945321 00000	SOCKET HEAD SCREW
80	946971 00000	STUD
81	947504 00000	WASHER
82	947104 00000	HEX.NUT
83	952019 00000	LOCATING PEG
85	025514 21100	GASKET
86	025515 21100	GASKET
88	560203 21300	COOLER
91	909514 00000	FILTER CARTRIDGE C 718 (1x) ²⁾
93	903800 70000	STUD
94	947105 00000	HEX.NUT
95	949450 00000	WASHER
97	950304 00000	WASHER
98	945321 00000	SOCKET HEAD SCREW
103	068801 21300	DUST SEPARATOR COVER
104	025515 21300	GASKET
110	921500 50000	HANDLE
121	560204 21300	COOLER
122	025506 21300	GASKET

**D**
Index**KDT 3.100**

Pos.	Ident No.	Description
123	066802 21300	PRESSURE CONNECTION BOX
125	025504 21300	GASKET
126	025514 21300	GASKET
131	948021 00000	SEALING RING
132	945374 00000	SOCKET HEAD SCREW
137	945322 00000	SOCKET HEAD SCREW
141	016604 21300	CONNECTING PIECE
146	025507 21300	GASKET
148	945364 00000	SOCKET HEAD SCREW
149	741310 30000	RUBBER BUFFER
161	918300 21300	COVERING HOOD
163	920800 21300	AIR GUIDE COVER RING
165	960700 21300	VENTILATOR HOOD
166	960701 21300	VENTILATOR HOOD
171	945371 00000	SOCKET HEAD SCREW
172	945372 00000	SOCKET HEAD SCREW
173	949806 00000	COUNTERSUNK SCREW
174	951703 00000	SPRING DISC
176	741302 00000	RUBBER BUFFER
177	945634 00000	THREADED PIN
178	948802 00000	RING SCREW
182	014902 21300	FLANGE
184	951916 00000	RUBBER BUSHING
185	948772 00000	PIPE RIVET
186	947508 00000	WASHER
188	945335 00000	SOCKET HEAD SCREW
190	951018 00000	STUD
192	947506 00000	WASHER
193	947106 00000	HEX.NUT
197	902108 00000	COUPLING
199	902210 00000	COUPLING DISC
241	012200 21200	OIL-PIPE
244	912300 00000	CONNECTING SCREW
245	009400 19000	HOLLOW HOLDING SCREW
247	948074 00000	SEALING RING
248	948021 00000	SEALING RING
250	949002 00000	GREASE NIPPLE
345	728000 99622	PRESSURE REGULATION VALVE / 8,7 PSI
345	728001 99622	PRESSURE REGULATION VALVE / 14,5 PSI
345	728002 99622	PRESSURE REGULATING VALVE / 29 PSI
345	728003 99622	PRESSURE REGULATING VALVE / 4,35 PSI
353	953111 00000	NOZZLE
354	912805 00000	PLUG
GREASE	743303 00000	AMBLYGON TA15/2 (GREASE PRESS, 50g)

¹⁾ Set of seals - 54900021300 - Pos.: 17, 20, 24, 62, 75, 76, 85, 86, 104, 122, 125, 126, 146²⁾ necessary order quantity / maintenance**OPTIONAL**

KDT 3.100	USA	all types
	B5-300	Special design – motor flange
	/0-05	Special design – corrosion protection
	/0-52	Special design – corrosion protection and special vanes
	/0-54	Special design – refrigeration
	/6-29	Special design – corrosion protection and intensified pressure
	/6-54	Special design – corrosion protection / refrigeration
	/6-71	Special design – corrosion protection and intensified pressure

Items different from standard appliance see appendix (back of drawing) 

Pos.	No. Identification	Designation
...	549000 21300	JEU COMPLET DE JOINTS ¹⁾
6	000101 21200	CORP DE POMPE
9	020005 21200	PISTON
11	901333 00004	PALETTE DE CHARBON (KIT) ²⁾
15	000803 21200	COUVERCLE A GAUCHE
16	000701 21200	COUVERCLE A DROITE
17	025512 21200	JOINT
18	001100 21200	COUVERCLE DE ROULEMENTE
19	001000 21200	COUVERCLE DE ROULEMENTE
20	025513 21200	JOINT
24	911312 00000	JOINT
25	917152 00000	DISQUE DE COMPENSATION
26	906540 00000	BAGUE D'ETANCHEITE P.L'AXE
27	906620 00000	ROULEMENT A BILLES, 3205 C3 GBB20
28	906657 00000	ROULEMENT A BILLES, NU 205 E GBB30
31	511400 10100	JEU DISQUE DE TOLERANCE
38	016801 21100	DISQUE DE SERRAGE
39	949807 00000	VIS
41	945224 00000	VIS HEXAGONALE
42	945222 00000	VIS HEXAGONALE
45	948742 00000	GOUPILLE CYLINDRIQUE
47	947736 00000	CLAVETTE
50	053201 21300	BRIDE DE RACCORDEMENT
52	950308 00000	RONDELLE
53	945331 00000	VIS HEXAGONALE INTERNE
55	011400 21200	DISQUE AJUSTAGE
56	544500 21200	ACCOUPLLEMENT AVEC VENTILATEUR
57	949409 00000	RONDELLE
58	945270 00000	VIS BOUT D'ARBRE
61	040102 21300	BOITE POUR FILTRE
62	025501 21300	JOINT
64	951009 00000	PRISONNIER
65	951003 00000	PRISONNIER
67	964407 00000	TUBE SILENCIEUX
68	909507 00000	CARTOUCHE FILTRANTE C 1112/2 (2x) ²⁾
71	009000 27000	RESSORT-JAME
72	948750 00000	RIVET AVEUGLIE
73	040204 21300	COUVERCLE DE FILTRE
75	025518 21300	JOINT
76	025516 21100	JOINT
77	022802 21100	SUPPORT FILTRE
79	945321 00000	VIS HEXAGONALE INTERNE
80	946971 00000	PRISONNIER
81	947504 00000	RONDELLE
82	947104 00000	ECROU A 6PANS
83	952019 00000	DOUILLE DE ETRAGE
85	025514 21100	JOINT
86	025515 21100	JOINT
88	560203 21300	REFROIDISSEUR
91	909514 00000	CARTOUCHE FILTRANTE C 718 (1x) ²⁾
93	903800 70000	PRISONNIER
94	947105 00000	ECROU A 6 PANS
95	949450 00000	RONDELLE
97	950304 00000	RONDELLE
98	945321 00000	VIS HEXAGONALE INTERNE
103	068801 21300	COUVERCLE
104	025515 21300	JOINT
110	921500 50000	POIGNEE
121	560204 21300	REFROIDISSEUR
122	025506 21300	JOINT

Pos.	No. Identification	Designation
123	066802 21300	BOITIER DE RACCORD DE REFOULEMENT
125	025504 21300	JOINT
126	025514 21300	JOINT
131	948021 00000	JOINT
132	945374 00000	VIS HEXAGONALE INTERNE
137	945322 00000	VIS HEXAGONALE INTERNE
141	016604 21300	PIECE RACCORD
146	025507 21300	JOINT
148	945364 00000	VIS HEXAGONALE INTERNE
149	741310 30000	AMORTISSEUR EN CAOUTCHOUC
161	918300 21300	CARTER
163	920800 21300	CAPOT DE CANALISATION DE L'AIR
165	960700 21300	CARTER DE VENTILATEUR
166	960701 21300	CARTER DE VENTILATEUR
171	945371 00000	VIS HEXAGONALE INTERNE
172	945372 00000	VIS HEXAGONALE INTERNE
173	949806 00000	VIS À TÊTE NOYÉE
174	951703 00000	DISQUE DE RESSORT
176	741302 00000	AMORTISSEUR EN CAOUTCHOUC
177	945634 00000	GOUPILLE FILETEE
178	948802 00000	PITON
182	014902 21300	BRIDE
184	951916 00000	PROTECTION EN CAOUTCHOUC
185	948772 00000	RIVET TUBE
186	947508 00000	RONDELLE
188	945335 00000	VIS HEXAGONALE INTERNE
190	951018 00000	PRISONNIER
192	947506 00000	RONDELLE
193	947106 00000	ECROU A 6 PANS
197	902108 00000	ACCOUPLLEMENT
199	902210 00000	DISQUE D'ACCOUPLLEMENT
241	012200 21200	TUYEAU DE GRAISSAGE
244	912300 00000	VIS DE RACCORD
245	009400 19000	VIS CREUSE DE FIXATION
247	948074 00000	JOINT
248	948021 00000	JOINT
250	949002 00000	GRAISSEUR
345	728000 99622	SOUPAPE REGLAGE PRESSION / 0,6 BAR
345	728001 99622	SOUPAPE REGLAGE PRESSION / 1,0 BAR
345	728002 99622	SOUPAPE REGLAGE PRESSION / 2,0 BAR
345	728003 99622	SOUPAPE REGLAGE PRESSION / 0,3 BAR
353	953111 00000	BUSE
354	912805 00000	BOUCHON
GRAISSE	743303 00000	AMBLYGON TA15/2 (POMPE À GRAISSE, 50g)



¹⁾ Jeu de joints - 54900021300 - Pos.: 17, 20, 24, 62, 75, 76, 85, 86, 104, 122, 125, 126, 146

²⁾ quantité nécessaire / entretien

EN OPTION

KDT 3.100	USA	Tous les fabrication
	B5-300	Fabrication spéciale – bride de moteur
	/0-05	Fabrication spéciale – protection contre la corrosion
	/0-52	Fabrication spéciale – protection contre la corrosion et palette spéciale
	/0-54	Fabrication spéciale – réfrigération
	/6-29	Fabrication spéciale – protection contre la corrosion et pression d'amplification
	/6-54	Fabrication spéciale – protection contre la corrosion / réfrigération
	/6-71	Fabrication spéciale – protection contre la corrosion et pression d'amplification

Articles divergents vis-à-vis de l'appareil standard, voir annexe (dos du dessin / du plan)

Pos.	No. Identificazione	Designazione
...	549000 21300	SERIE COMPLETA DI GUARNIZIONI ¹⁾
6	000101 21200	CARCASSA
9	020005 21200	ROTORE
11	901333 00004	PALETTE DI CHARBONE (KIT) ²⁾
15	000803 21200	COPERCHIO SINISTRA
16	000701 21200	COPERCHIO DESTRA
17	025512 21200	GUARNIZIONE
18	001100 21200	COPERCHIO CUSCINETTO
19	001000 21200	COPERCHIO CUSCINETTO
20	025513 21200	GUARNIZIONE
24	911312 00000	GUARNIZIONE
25	917152 00000	DISCO COMPENSATORE
26	906540 00000	GUARNIZIONE PER L'ALBERO
27	906620 00000	CUSCINETTO A SFERA, 3205 C3 GBB20
28	906657 00000	CUSCINETTO A SFERA, NU 205 E GBB30
31	511400 10100	SERIE DISCO GIUOCO
38	016801 21100	DISCO DI FISSAGGIO
39	949807 00000	VITE
41	945224 00000	VITE ESAGONALE
42	945222 00000	VITE ESAGONALE
45	948742 00000	PERNO
47	947736 00000	CHIAVETTA
50	053201 21300	FLANGIA DI RACCORDE
52	950308 00000	RONDELLA
53	945331 00000	VITE ESAGONALE INTERNA
55	011400 21200	DISCO GIUOCO
56	544500 21200	GIUNTO CON VENTILATORE
57	949409 00000	RONDELLA
58	945270 00000	VITE DI CHIUSURA ALBERO
61	040102 21300	CONTENITORE FILTRO
62	025501 21300	GUARNIZIONE
64	951009 00000	L'ASTA A VITE
65	951003 00000	L'ASTA A VITE
67	964407 00000	TUBO SILENZIATORE
68	909507 00000	CARTUCCIA FILTRO C 1112/2 (2x) ²⁾
71	009000 27000	MOLLA
72	948750 00000	RIVETTO CIECO
73	040204 21300	COPERCHIO FILTRO
75	025518 21300	GUARNIZIONE
76	025516 21100	GUARNIZIONE
77	022802 21100	SUPPORTO FILTRO
79	945321 00000	VITE ESAGONALE INTERNA
80	946971 00000	L'ASTA A VITE
81	947504 00000	RONDELLA
82	947104 00000	DADO ESAGONALE
83	952019 00000	SPINE DI RISCONTRO
85	025514 21100	GUARNIZIONE
86	025515 21100	GUARNIZIONE
88	560203 21300	RAFFREDDATORE
91	909514 00000	CARTUCCIA FILTRO C 718 (1x) ²⁾
93	903800 70000	L'ASTA A VITE
94	947105 00000	DADO ESAGONALE
95	949450 00000	RONDELLA
97	950304 00000	RONDELLA
98	945321 00000	VITE ESAGONALE INTERNA
103	068801 21300	COPERCHIO
104	025515 21300	GUARNIZIONI
110	921500 50000	MANETTA
121	560204 21300	RAFFREDDATORE
122	025506 21300	GUARNIZIONE

Pos.	No. Identificazione	Designazione
123	066802 21300	SCATOLA DI RACCORDO DI MANDATA
125	025504 21300	GUARNIZIONE
126	025514 21300	GUARNIZIONI
131	948021 00000	ANELLO GUARNIZIONE
132	945374 00000	VITE ESAGONALE INTERNA
137	945322 00000	VITE ESAGONALE INTERNA
141	016604 21300	PEZZI RACCORDI
146	025507 21300	GUARNIZIONE
148	945364 00000	VITE ESAGONALE INTERNA
149	741310 30000	AMMORTIZZATORE IN GOMMA
161	918300 21300	CARTER
163	920800 21300	CAPPOTTA DEL CONDOTTA ARIA
165	960700 21300	CARTER VENTILATORE
166	960701 21300	CARTER VENTILATORE
171	945371 00000	VITE ESAGONALE INTERNA
172	945372 00000	VITE ESAGONALE INTERNA
173	949806 00000	VITE A TESTA SVASATA
174	951703 00000	DISCO A MOLLA
176	741302 00000	AMMORTIZZATORE IN GOMMA
177	945634 00000	SPINA FILETTATURA
178	948802 00000	GANCIO
182	014902 21300	FLANGIA
184	951916 00000	PROTEZIONE IN GOMMA
185	948772 00000	CHIODO TUBOLARE
186	947508 00000	RONDELLA
188	945335 00000	VITE ESAGONALE INTERNA
190	951018 00000	L'ASTA A VITE
192	947506 00000	RONDELLA
193	947106 00000	DADO ESAGONALE
197	902108 00000	GIUNTO
199	902210 00000	DISCO GIUNTO
241	012200 21200	CONDOTTO
244	912300 00000	ATTACO FILETTATO
245	009400 19000	VITE PASSAGGIO OLIO
247	948074 00000	ANELLO GUARNIZIONE
248	948021 00000	ANELLO GUARNIZIONE
250	949002 00000	RACCORDO DI LUBRIFICAZIONE
345	728000 99622	VALVOLA REGOLAZIONE PRESSIONE / 0,6 BAR
345	728001 99622	VALVOLA REGOLAZIONE PRESSIONE / 1,0 BAR
345	728002 99622	VALVOLA REGOLAZIONE PRESSIONE / 2,0 BAR
345	728003 99622	VALVOLA REGOLAZIONE PRESSIONE / 0,3 BAR
353	953111 00000	UGGELLO
354	912805 00000	TAPPO DI CHIUSURA
GRASSO	743303 00000	AMBLYGON TA15/2 (INGRASSATORE A PISTOLA, 50g)



¹⁾ Serie di guarnizione - 54900021300 - Pos.: 17, 20, 24, 62, 75, 76, 85, 86, 104, 122, 125, 126, 146

²⁾ quantità di ordinazione necessari / manutenzione

OPZIONALE

KDT 3.100	USA	Tutte tipi
	B5-300	Modello speciale - flangia del motore
	/0-05	Modello speciale - protezione anti-corrosione
	/0-52	Modello speciale - protezione anti-corrosione e palette speciale
	/0-54	Modello speciale - refrigerazione
	/6-29	Modello speciale - protezione anti-corrosione e pressione de amplificazione
	/6-54	Modello speciale - protezione anti-corrosione / refrigerazione
	/6-71	Modello speciale - protezione anti-corrosione e pressione de amplificazione

Vedere allegato (retro del disegno) per le posizioni divergenti dall'apparecchio standard



Pos.	No. De pedido	Descripción	
...	549000 21300	JUNTA COMPLETA ¹⁾	
6	000101 21200	CARCASA	
9	020005 21200	ÉMBOLO, ACABADO	
11	901333 00004	EMPUJADOR (KIT) ²⁾	
15	000803 21200	TAPA LATERAL	
16	000701 21200	TAPA LATERAL DERECHA	
17	025512 21200	JUNTA	
18	001100 21200	TAPA DE COJINETE	
19	001000 21200	TAPA DE COJINETE	
20	025513 21200	JUNTA	
24	911312 00000	MANGUERA DE JUNTA	
25	917152 00000	ARANDELA DE COMPENSACIÓN	
26	906540 00000	ANILLO DE JUNTA DE ÁRBOL	
27	906620 00000	COJINETE DE RODAMIENTO, 3205 C3 GBB20	
28	906657 00000	COJINETE DE RODAMIENTO, NU 205 E GBB30	
31	511400 10100	JUEGO DE ARANDELAS DISTANCIADORAS	
38	016801 21100	ARANDELA TENSORA	
39	949807 00000	TORNILLO AVELLANADO	
41	945224 00000	TORNILLO DE CABEZA HEXAGONAL	
42	945222 00000	TORNILLO DE CABEZA HEXAGONAL	
45	948742 00000	PASADOR ENTALLADO DE AJUSTE	
47	947736 00000	LENGÜETA DE AJUSTE	
50	053201 21300	FAROL	
52	950308 00000	ARANDELA	
53	945331 00000	TORNILLO HEXAGONAL INTERIOR	
55	011400 21200	ARANDELA DISTANCIADORA	
56	544500 21200	MITAD DE ACOPLAMIENTO CON VENTILADOR	
57	949409 00000	ARANDELA	
58	945270 00000	TORNILLO TERMINAL DE ÁRBOL	
61	040102 21300	CARCASA DE FILTRO	
62	025501 21300	JUNTA	
64	951009 00000	ESPÁRRAGO	
65	951003 00000	ESPÁRRAGO	
67	964407 00000	TUBO DE SILENCIADOR	
68	909507 00000	CARTUCHO DE FILTRO C 1112/2 (2x) ²⁾	
71	009000 27000	MUELLE DE PRESIÓN	
72	948750 00000	REMACHE CIEGO	
73	040204 21300	TAPA DE FILTRO	
75	025518 21300	JUNTA	
76	025516 21100	JUNTA	
77	022802 21100	SOPORTE DE FILTRO	
79	945321 00000	TORNILLO HEXAGONAL INTERIOR	
80	946971 00000	ESPÁRRAGO	
81	947504 00000	ARANDELA	
82	947104 00000	TUERCA HEXAGONAL	
83	952019 00000	CASQUILLO TENSOR	
85	025514 21100	JUNTA	
86	025515 21100	JUNTA	
88	560203 21300	REFRIGERADOR	
91	909514 00000	CARTUCHO DE FILTRO C 718 (1x) ²⁾	
93	903800 70000	ESPÁRRAGO	
94	947105 00000	TUERCA HEXAGONAL	
95	949450 00000	ARANDELA	
97	950304 00000	ARANDELA	
98	945321 00000	TORNILLO HEXAGONAL INTERIOR	
103	068801 21300	TAPA DE SEPARADOR DE POLVO	
104	025515 21300	JUNTA	
110	921500 50000	EMPUÑADURA	
121	560204 21300	REFRIGERADOR	
122	025506 21300	JUNTA	

Pos.	No. De pedido	Descripción	
123	066802 21300	CAJA DE EMPALME DE PRESIÓN	
125	025504 21300	JUNTA	
126	025514 21300	JUNTA	
131	948021 00000	ANILLO DE JUNTA	
132	945374 00000	TORNILLO HEXAGONAL INTERIOR	
137	945322 00000	TORNILLO HEXAGONAL INTERIOR	
141	016604 21300	PIEZA DE EMPALME	
146	025507 21300	JUNTA	
148	945364 00000	TORNILLO HEXAGONAL INTERIOR	
149	741310 30000	AMORTIGUADOR DE GOMA	
161	918300 21300	CAPERUZA DE RECUBRIMIENTO	
163	920800 21300	CAPERUZA CONDUCTOR DE AIRE	
165	960700 21300	CAPERUZA DE VENTILADOR	
166	960701 21300	CAPERUZA DE VENTILADOR	
171	945371 00000	TORNILLO HEXAGONAL INTERIOR	
172	945372 00000	TORNILLO HEXAGONAL INTERIOR	
173	949806 00000	TORNILLO AVELLANADO	
174	951703 00000	ARANDELA ELÁSTICA	
176	741302 00000	AMORTIGUADOR DE GOMA	
177	945634 00000	VARILLA ROSCADA	
178	948802 00000	TORNILLO DE CÁNCAMO	
182	014902 21300	BRIDA INTERMEDIA	
184	951916 00000	BOQUILLA DE CABLE	
185	948772 00000	REMACHE TUBULAR	
186	947508 00000	ARANDELA	
188	945335 00000	TORNILLO HEXAGONAL INTERIOR	
190	951018 00000	ESPÁRRAGO	
192	947506 00000	ARANDELA	
193	947106 00000	TUERCA HEXAGONAL	
197	902108 00000	MITAD DE ACOPLAMIENTO (MOT)	
199	902210 00000	DISCO DE ACOPLAMIENTO	
241	012200 21200	CONDUCTO	
244	912300 00000	TORNILLO DE EMPALME	
245	009400 19000	TORNILLO DE PIEZA ESFÉRICA	
247	948074 00000	ANILLO DE JUNTA	
248	948021 00000	ANILLO DE JUNTA	
250	949002 00000	BOQUILLA DE TOLVA DE LUBRICACIÓN	
345	728000 99622	VÁLVULA REGULADORA DE PRESIÓN / 0,6 BAR	
345	728001 99622	VÁLVULA REGULADORA DE PRESIÓN / 1,0 BAR	
345	728002 99622	VÁLVULA REGULADORA DE PRESIÓN / 2,0 BAR	
345	728003 99622	VÁLVULA REGULADORA DE PRESIÓN / 0,3 BAR	
353	953111 00000	TOBERA DE SILENCIADOR	
354	912805 00000	TAPÓN DE DESGASTE	
GRASA	743303 00000	AMBLYGON TA15/2 (PISTOLA DE GRASA, 50g)	



¹⁾ Junta completa - 54900021300 - Pos.: 17, 20, 24, 62, 75, 76, 85, 86, 104, 122, 125, 126, 146

²⁾ cantidad necesario / mantenimiento

OPCIONAL

KDT 3.100	USA	Versión general
	B5-300	Versión especial – brida de motor
	/0-05	Versión especial – protección contra la corrosión
	/0-52	Versión especial – protección contra la corrosión y embujador especial
	/0-54	Versión especial – refrigeración
	/6-29	Versión especial – protección contra la corrosión y presión de amplificación
	/6-54	Versión especial – protección contra la corrosión / refrigeración
	/6-71	Versión especial – protección contra la corrosión y presión de amplificación

Para posiciones que derivan del aparato standard véase apéndice (lado trasero del plano) 

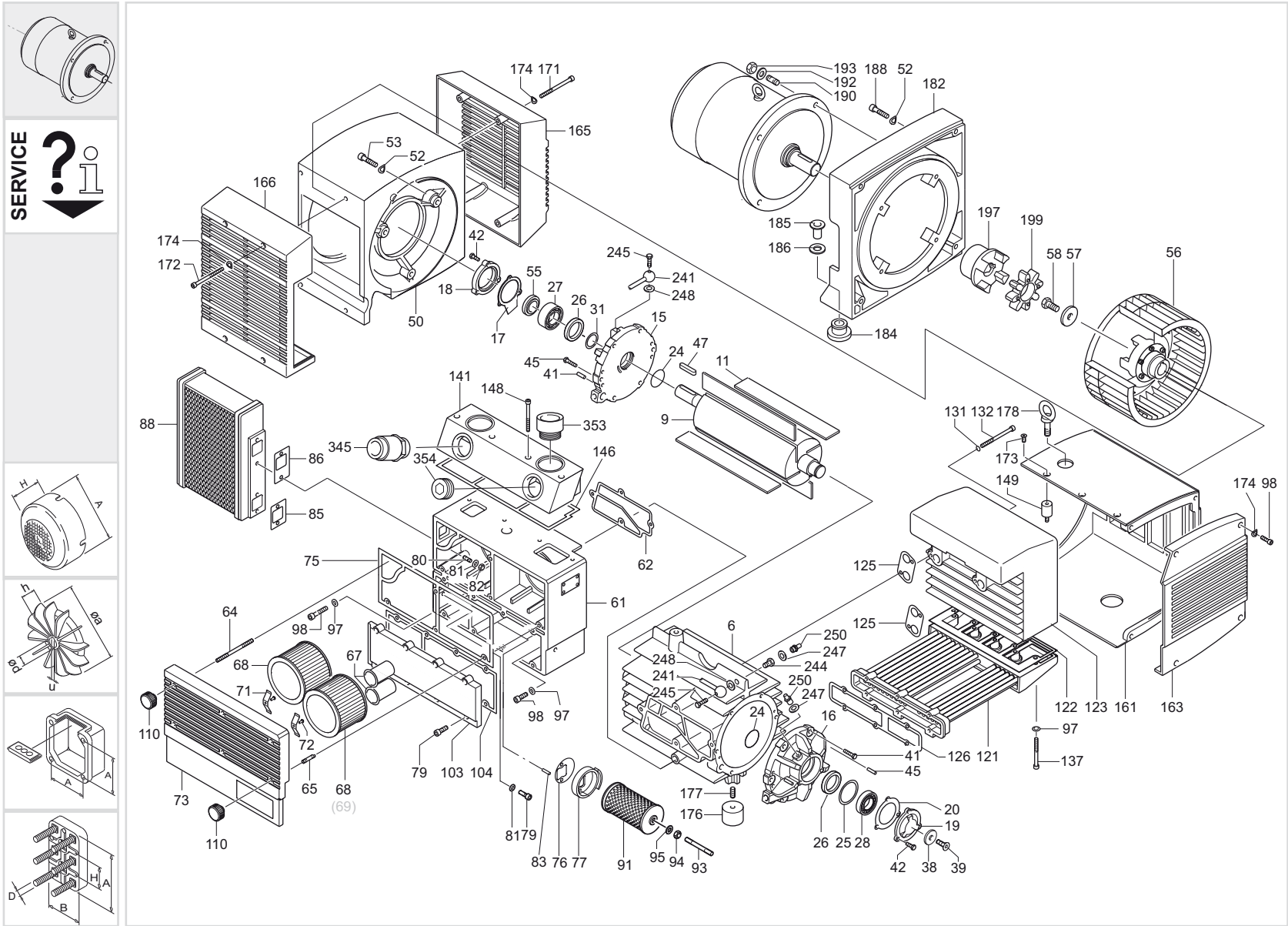











SERVICE ?

standard

KDT 3.100

optional
en option
opcionale
opcional

optional en option optionale opcional 	Variante(n) Modifications Variantes	Pos ³⁾	Bestell Nr. / Ident No. / No. Identification / No. Identificazione / No. De pedido		Beschreibung / Description / Designation / Designazione / Descripcion
					
KDT 3.100/XX	KDT 3.100 (USA)	182 197 234 236	014903 21300	014902-21300 902108-00000 -	ZWISCHENFLANSCH / INTERMEDIATE FLANGE / BRIDE INTERMEDIAIRE / FLANGE INTERMEDIA / BRIDA INTERMEDIA MOTORKÜPPLUNG / COUPLING / ACCOUPLEMENT / GIUNTO / ACOPLAMIENTO ZWISCHENFLANSCH / INTERMEDIATE FLANGE / BRIDE INTERMEDIAIRE / FLANGE INTERMEDIA / BRIDA INTERMEDIA MOTORKÜPPLUNG / COUPLING / ACCOUPLEMENT / GIUNTO / ACOPLAMIENTO
	KDT 3.100 (B5-300)	182 190 197	014903 21300	014902-21300 951018-00000 902100-21900	ZWISCHENFLANSCH / INTERMEDIATE FLANGE / BRIDE INTERMEDIAIRE / FLANGE INTERMEDIA / BRIDA INTERMEDIA STIFTSCHRAUBE / STUD / GOUJON PRISONNIER / VITE PRIGIONIERA / PRISIONERO CON ROSCA MOTORKÜPPLUNG / COUPLING / ACCOUPLEMENT / GIUNTO / ACOPLAMIENTO
	KDT 3.100/0-05	9	020006 21200	020005-21200	KOLBEN / ROTOR / PISTON / ROTORE / ÉMBOLO
	KDT 3.100/0-52	9 11 345 352 353 403	020006 21200 901380 00004	020005-21200 901333-00004 72800X-99622 953111-00000	KOLBEN / ROTOR / PISTON / ROTORE / ÉMBOLO SATZ (KIT) SCHIEBER / VANES / PALETTE / PALETTE / EMPUJADOR DRUCKREGULIERVENTIL / PRESSURE REGULATING VALVE / SOUPAPE REGLAGE PRESSION / VALVOLA REGOLAZIONE PRESSIONE / VÁLVULA REGULADORA DE PRESIÓN SCHALLDÄMPFERROHR / SILENCER TUBE / TUBE SILENCIEUX / TUBO SILENZIATORE / TUBO SILENCIADOR GEWINDERING / THREADED RING / BAGUE FILETTÉE / ANELLO FILETTATO / ANILLO ROSCADO DRUCKREGULIERVENTIL 2,2 BAR / PRESSURE REGULATING VALVE 32 PSI / SOUPAPE REGLAGE PRESSION 2,2 BAR / VALVOLA REGOLAZIONE PRESSIONE 2,2 BAR / VÁLVULA REGULADORA DE PRESIÓN 2,2 BAR
	KDT 3.100/0-54	88 230	019901 21100	560203-21300	KÜHLER / COOLER / REFRIGÉRISEUR / RAFFREDDATORE / REFRIGERADOR UMLENKSTÜCK / RETURN PIECE / PIECE DE RETOUR / PEZZO INVERSIONE / PIEZA DE DESVIACIÓN
	KDT 3.100/6	6 9 11 15 16 68 69	000111 21200 020011 21200 901380 00004 000811 21200 000711 21200	000101-21200 020005-21200 901333-00004 000803-21200 000701-21200 909507-00000 909507-00000	GEHÄUSE / PUMP BODY / CORP DE POMPE / CARCASSA / CARCASA KOLBEN / ROTOR / PISTON / ROTORE / ÉMBOLO SATZ (KIT) SCHIEBER / VANES / PALETTE / PALETTE / EMPUJADOR SEITENDECKEL, LINKS / LID LEFT / COUVERCLE A GAUCHE / COPERCHIO SINISTRA / TAPA LATERAL IZQUIERDA SEITENDECKEL, RECHTS / LID RIGHT / COUVERCLE A DROITE / COPERCHIO DESTRA / TAPA LATERAL DERECHA FILTERPATRONE (1x) / FILTER CARTRIDGE / CARTOUCHE FILTRANTE / CARTUCCIA FILTRO / CARTUCHO DE FILTRO FILTERPATRONE (1x POLYESTER) / FILTER CARTRIDGE / CARTOUCHE FILTRANTE / CARTUCCIA FILTRO / CARTUCHO DE FILTRO
	  KDT 3.100/6-29	9 11 76 77 83 88 91 93 94 95 230 378	020012 21200 901380 00007	020005-21200 901333-00004 025516-21100 022802-21100 952019-00000 560203-21300 909514-00000 903800-70000 947105-00000 949450-00000	KOLBEN / ROTOR / PISTON / ROTORE / ÉMBOLO SATZ (KIT) SCHIEBER / VANES / PALETTE / PALETTE / EMPUJADOR DICHTUNG / GASKET / JOINT / GUARNIZIONE / JUNTA FILTERTRÄGER / FILTER HOLDER / SUPPORT FILTRE / SUPPORTO FILTRO / SOPORTE DE FILTRO SPANNHÜLSE / LOCATING PEG / DOUILLE DE ETRAGE / SPINE DI RISCINTRO / CASQUILLO TENSOR KÜHLER / COOLER / REFRIGÉRISEUR / RAFFREDDATORE / REFRIGERADOR FILTERPATRONE / FILTER CARTRIDGE / CARTOUCHE FILTRANTE / CARTUCCIA FILTRO / CARTUCHO DE FILTRO STIFTSCHRAUBE / STUD / GOUJON PRISONNIER / VITE PRIGIONIERA / PRISIONERO CON ROSCA SECHSKANTMUTTER / HEX NUT / ÉCROU A 6 PANS / DADO ESAGONALE / TUERCA HEXAGONAL U-SCHEIBE / WASHER / RONDELLE / RONDELLA / ARANDELA UMLENKSTÜCK / RETURN PIECE / PIECE DE RETOUR / PEZZO INVERSIONE / PIEZA DE DESVIACIÓN DICHTUNG / GASKET / JOINT / GUARNIZIONE / JUNTA
	    KDT 3.100/6-71	73 110 163	040205 21300	040204-21300 921500-50000 920800-21300	FILTERDECKEL / FILTER COVER / COUVERCLE DE FILTRE / COPERCHIO FILTRO / TAPA DE FILTRO HUTMUTTER / CAP NUT / ÉCROU BORGNE / DADO CIECO / TUERCA DE CAPERUZA LUFTLEITRING / AIR GUIDE COVER RING / CAPOT DE CANALISATION DE L'AIR / CAPOTTA DEL CONDOTTARIA / CAPERUZA CONDUCTOR DE AIRE
	  KDT 3.100/6-54	88 230	019901 21100	560203-21300	KÜHLER / COOLER / REFRIGÉRISEUR / RAFFREDDATORE / REFRIGERADOR UMLENKSTÜCK / RETURN PIECE / PIECE DE RETOUR / PEZZO INVERSIONE / PIEZA DE DESVIACIÓN

³⁾ variantenabhängige Bauteile / variant-dependent components / composants variante-dependantes / componenti variante-dispendenti / componentes variante-dependientes